

PERFECT FIT

COLLECTION SIDE CABINETS

Efficiency rules.



MCC
Modular & Custom Cabinets



**TAILORED SOLUTIONS
FOR YOUR DENTAL PRACTICE**

Our Perfect Fit Side Cabinets are just what you need when you are running a busy practice. Everything is close at hand, at the side of your stations.

Consider the following features and benefits of our Side Cabinets:

- Our Perfect Fit Side Cabinets will enhance any operatory work environment.
- Comes with your choice of smooth, seamless Solid Surface or Caesarstone® tops for a beautiful look and easy cleaning.
- A host of designer finishes to complement any decor.
- Can be customized to include several efficient storage solutions, integrated counter waste drop and convenient under mounted stainless steel sink locations.
- All hardware and plumbing fixtures are included.

Talk to our experts about any special features you may require. A few simple custom modifications are a cost effective way to guarantee the 'perfect fit' for your practice.



PFS420

Key Features Side Cabinets

- Optional solid surface or Caesarstone® countertop
- PVC edging
- MCC's new modern design
- Integrated counter waste drop
- Under mounted stainless steel Sink included with solid surface counter only
- Hardware and plumbing fixtures included

With our European High Gloss BRILLIANCE Finish* the Perfect Fit Side Cabinet becomes a thing of beauty. Water, stain and scratch resistant. A fine selection of colors and wood grains to choose from.



'Green' construction. Our Perfect Fit Cabinetry is also available using environmentally friendly manufacturing techniques. 'Green' construction means our cabinets contain no urea formaldehyde resins and are built with water-based adhesives. As a result, they are LEEDS compliant.

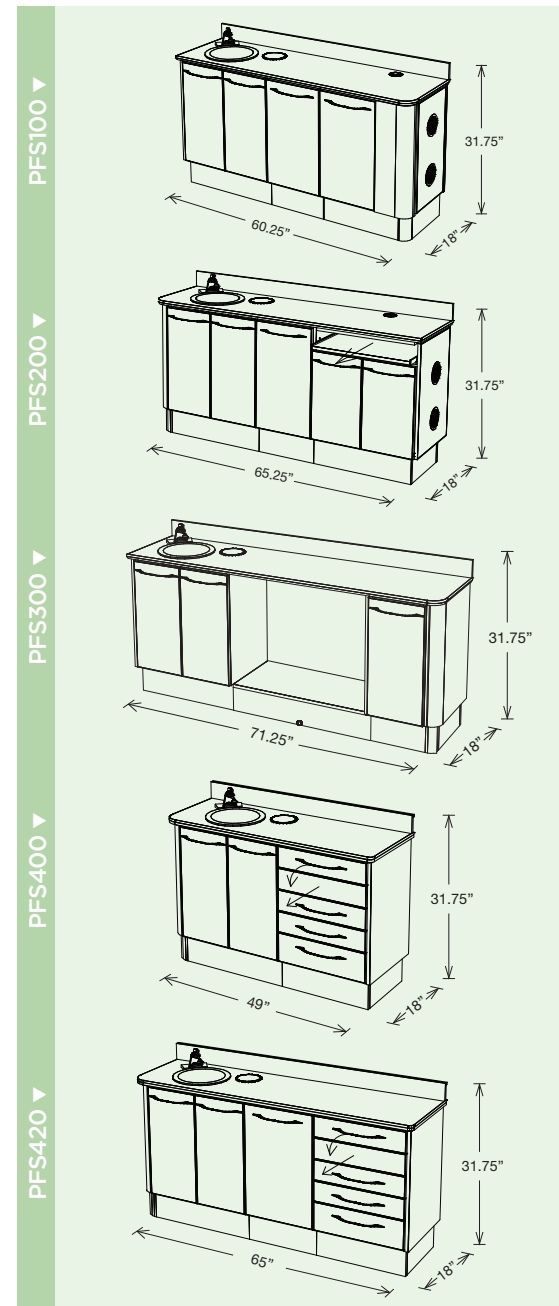

PFS100



PFS200



PFS300



PFS400



Front waste available



PFS400 Flip down equipment drawer

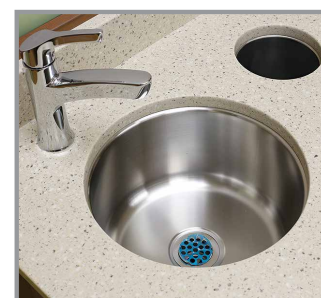

Integrated waste drop

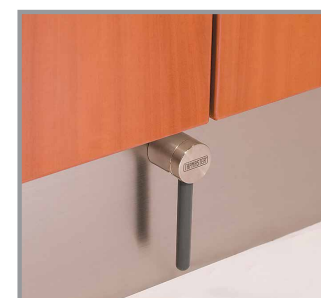

Hands-free water activation



CPU storage (PFS100 shown)



Keyboard slide-out (PFS200)

FEATURED COLORS

Choose from a wide variety of the latest solid colors and designer hues and classic wood grain patterns.

LAMINATE STANDARD COLLECTION



White • 949-58



Antique White • 932-58



Folkstone • 927-58



Crystal • D388-60 (Surf)



Prestige Maple • L476 Matte Finish
(Amber Curly Maple)



Pearwood • WX031



Versailles Anigre • 7923-60
(Slipping Seattle Java)



Billmore Cherry • 7924-60



Tuxedo • L477



Starry Night • L762 Matte Finish



Milky Way • L767 Matte Finish



Portobello • L495 Urbana Finish



Truffle • L479 Matte Finish



Summer Breeze • L540 Alto Finish



White Chocolate • L492 Urbana Finish



Latitude North • L530 Alto Finish



Maritime Dune • L555 Urbana Finish



Brushed Aluminum • L474 Matte Finish

QUARTZ COLLECTION by caesarstone®

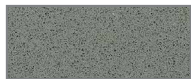

Cement • 3040



Jet Black • 3100



Stone Grey • 4030



Creme Brule • 4255



Ocean Foam • 6141



Quartz Reflections • 7141

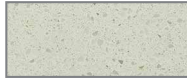

Ice Snow • 9141

SOLID SURFACE COLLECTION



Light Beige • 254

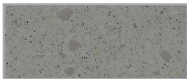

Blue Bayou • 510



Arctic Granite • 603

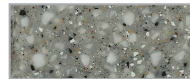

Platinum Granite • 615



Moonstone Granite • 674

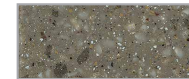

Cinder Granite • 679 AR

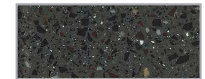

Midnight Granite • 690



Sanibel Granite • 691

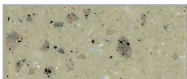

Rocky Road Granite • 729 AR

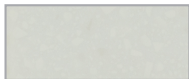

Aspen Granite • 780

BRILLIANCE* COLLECTION



PRUGNO • 8440 - Front



PRUGNO SILVA • 71512 - Front

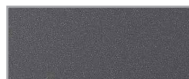

ANTRACITE • 4517 - Front



TORTORA • 8238 - Front

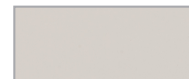

GRIGIO CHIARO • 4523 - Front



Side Panels • L474

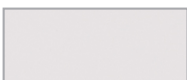

WHITE - Top • 033

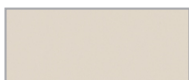

BONE - Top • 003

*Up-charge will apply.

Let us help you make your color choices.

We're here to help you choose the surface colors that best match your office style and design objectives. Ask us for assistance. We'll be happy to show you all the color choices available to you.

Other colors are available upon request, up-charge will apply. Prices and colors are subject to change without notice. The products and colors shown in this brochure should only be used as a guide and are not absolute and may vary. Please contact one of our sales representatives for accurate color samples and information.

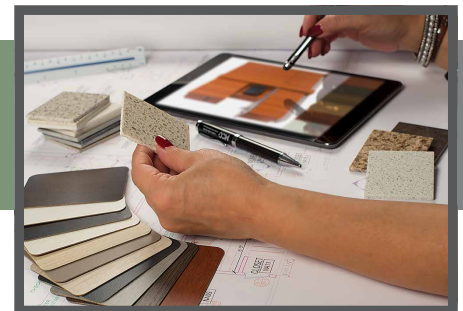

Modular & Custom Cabinets



TAILORED SOLUTIONS

FOR YOUR DENTAL PRACTICE

Sterilization Centers • Rear Cabinets • Side Cabinets • Center Island Units • Mobiles • Orthodontic Mobiles • Pediatric Benches • Brilliance Units

1-800-388-6236 | www.mccdental.com

FOLLOW US ON THE MAJOR SOCIAL NETWORKS

