

# PERFECT FIT

## COLLECTION

# REAR CABINETS

Efficiency rules.



**MCC**  
Modular & Custom Cabinets



**TAILORED SOLUTIONS**  
**FOR YOUR DENTAL PRACTICE**



# We've got your back. Literally. Everything you need fits perfectly in our **Perfect Fit Rear Cabinets**. Designed with efficiency in mind.

Since the early days at MCC, we have continually collaborated with dental professionals on the design of practice cabinets. The result of our efforts is the most efficient treatment station available. Quite simply, our Perfect Fit Rear Cabinets are industry leading. Consider the following:

- The dentist, assistant and patient all benefit from having instruments and equipment close at hand and in just the right place.
- To maximize the functionality of our Rear Cabinets, every corner, shelf and position has been transformed into useful space.
- We have kept our rear cabinets to the smallest footprint possible, while still accommodating everything required for today's well equipped dental facility.
- Some of the key features of our rear cabinets include optional Solid Surface or Caesarstone® countertops, 2 mm edging, CPU storage in the upper cabinet, and medical grade outlets integrated into the mid-section. There are also various options for mounting a monitor.

Investing in well designed, high quality cabinetry today pays high dividends down the road, as practices evolve to meet new and ever demanding needs.

*Talk to our experts about any special features you may require. A few simple custom modifications are a cost effective way to guarantee the 'perfect fit' for your practice.*



**PFR8144**

### Key Features

- Optional solid surface or Caesarstone® countertop
- PVC edging
- MCC's new modern design
- CPU storage in upper cabinet
- Ability to accommodate both left and right handed dentists
- Electrical outlet integrated into mid-section
- Finished back



Control access



CPU Storage



Side drawers with slide-out shelves



**'Green' construction.** Our Perfect Fit Cabinetry is also available using environmentally friendly manufacturing techniques. 'Green' construction means our cabinets contain no urea formaldehyde resins and are built with water-based adhesives. As a result, they are LEEDS compliant.



**PFRMS7644**

### Key Features

- Optional solid surface or Caesarstone® countertop
- PVC edging
- MCC's new modern design
- CPU storage in upper cabinet
- Multi sliding work surface
- Ability to accommodate both left and right handed dentists
- Electrical outlet integrated into mid-section
- Finished back



**PFRDS7644**

### Key Features

- Optional solid surface or Caesarstone® countertop
- PVC edging
- MCC's new modern design
- CPU storage in upper cabinet
- Left and right sliding pull out work surface
- Ability to accommodate both left and right handed dentists
- Electrical outlet integrated into mid-section
- Finished back



**PFR7644**

### Key Features

- Optional solid surface or Caesarstone® countertop
- PVC edging
- MCC's new modern design
- CPU storage in upper cabinet
- Sliding work surface
- Ability to accommodate both left and right handed dentists
- Electrical outlet integrated into mid-section
- Finished back



Assistant's under surface package



Assistant's slide-out work surface (PFR7644)



Side access panel

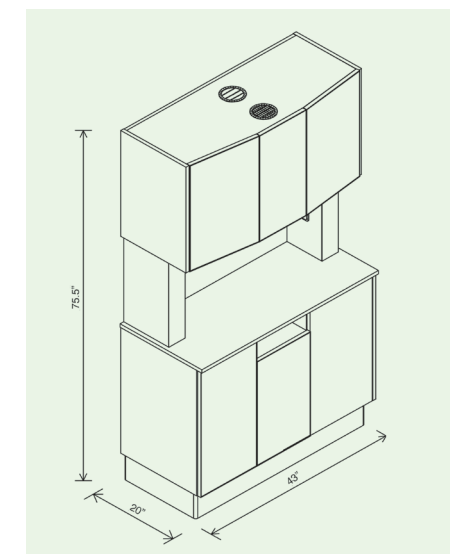



# FEATURED COLORS

Choose from a wide variety of the latest solid colors and designer hues and classic wood grain patterns.

## LAMINATE STANDARD COLLECTION



White • 949-58



Antique White • 932-58



Folkstone • 927-58



Crystal • D388-60 (Surf)



Prestige Maple • L476 Matte Finish  
(Amber Curly Maple)



Pearwood • WX031



Versailles Anigre • 7923-60  
(Slipping Seattle Java)



Biltmore Cherry • 7924-60



Tuxedo • L477



Starry Night • L762 Matte Finish



Milky Way • L767 Matte Finish



Portobello • L495 Urbana Finish



Truffle • L479 Matte Finish



Summer Breeze • L540 Alto Finish



White Chocolate • L492 Urbana Finish



Latitude North • L530 Alto Finish



Maritime Dune • L555 Urbana Finish



Brushed Aluminum • L474 Matte Finish

## QUARTZ COLLECTION by caesarstone® Quartz Surfaces

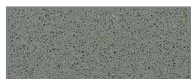

Cement • 3040



Jet Black • 3100



Stone Grey • 4030



Creme Brule • 4255



Ocean Foam • 6141



Quartz Reflections • 7141



Ice Snow • 9141

## SOLID SURFACE COLLECTION



Light Beige • 254

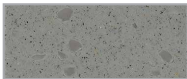

Blue Bayou • 510



Arctic Granite • 603

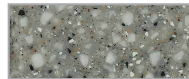

Platinum Granite • 615



Moonstone Granite • 674

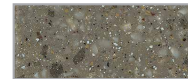

Cinder Granite • 679 AR

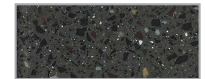

Midnight Granite • 690



Sanibel Granite • 691

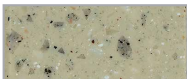

Rocky Road Granite • 729 AR



Aspen Granite • 780

## BRILLIANCE\* COLLECTION



PRUGNO • 8440 - Front



PRUGNO SILVA • 71512 - Front

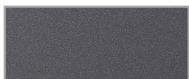

ANTRACITE • 4517 - Front



TORTORA • 8238 - Front

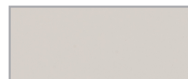

GRIGIO CHIARO • 4523 - Front



Side Panels • L474

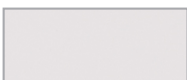

WHITE - Top • 033

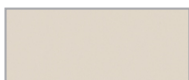

BONE - Top • 003

\*Up-charge will apply.

### Let us help you make your color choices.

We're here to help you choose the surface colors that best match your office style and design objectives. Ask us for assistance. We'll be happy to show you all the color choices available to you.

Other colors are available upon request, up-charge will apply. Prices and colors are subject to change without notice. The products and colors shown in this brochure should only be used as a guide and are not absolute and may vary. Please contact one of our sales representatives for accurate color samples and information.

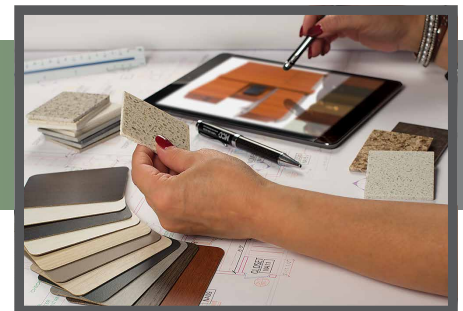

Modular & Custom Cabinets



**TAILORED SOLUTIONS**

**FOR YOUR DENTAL PRACTICE**

Sterilization Centers • Rear Cabinets • Side Cabinets • Center Island Units • Mobiles • Orthodontic Mobiles • Pediatric Benches • Brilliance Units

1-800-388-6236 | [www.mccdental.com](http://www.mccdental.com)

FOLLOW US ON THE MAJOR SOCIAL NETWORKS

