

MOBILE & ORTHO COLLECTIONS

Small is mighty.



MCC
Modular & Custom Cabinets



TAILORED SOLUTIONS
FOR YOUR DENTAL PRACTICE

See how some of our hardest working cabinets can work for you.

Promotional Mobile Features and Benefits:

- Durable laminate surfaces for easy cleaning.
- White coated metal drawer slides.
- Smooth flowing ball bearing glides for sliding tops.
- Strong rubber casters.
- PVC moldings for lasting protection.
- Two-year warranty.



MFB217SS (Side to side sliding top)
MFB217FB (Front to back sliding top)

ASSISTANT'S "ALABAMA" MOBILE
 21" W x 18.75" D x 32.25" H

Sliding counter top with amalgamator well. Includes one instrument drawer, two storage drawers and electrical power bar.

\$578.00



MFB217SSPK MOBILE

SAME FEATURES AS MFB217SS
 INCLUDES MB20 STORAGE ORGANIZER
 18" W x 7" D

Sliding counter top with amalgamator well. Includes one instrument drawer, two storage drawers, electrical power bar, three tubs, lids and mounting bracket. Available in white only. Also sold separately.

\$737.00



MFB218LT (Left pull out shelf)
MFB218RT (Right pull out shelf)

ASSISTANT'S ("NORTH CAROLINA") MOBILE
 21" W x 18.75" D x 32.25" H

Solid top with pull handle. Sliding side shelf (left or right). Includes pull out amalgamator drawer with drop leaf door, three instrument drawers and one storage drawer.

\$631.00



MFB218PKLT (Left pull out shelf)
MFB218PKRT (Right pull out shelf)

SAME FEATURES AS MFB218
 INCLUDES MB20 STORAGE ORGANIZER 18" W x 7" D

Includes three tubs, lids and mounting bracket. Available in white only. Also sold separately.

\$790.00





MFB210SP MOBILE

DOCTOR'S MOBILE

21" W x 18.75" D x 32.25" H

Includes four instrument drawers and three storage drawers

\$631.00

MB20 STORAGE ORGANIZER*

18" W x 7" D

Includes three tubs. Each tub comes with vertical divider and one half depth adjustment. Angle mounted for convenient access. Tubs and mounting bracket available in white only. Available on any mobile 20" wide or greater.

\$206.00

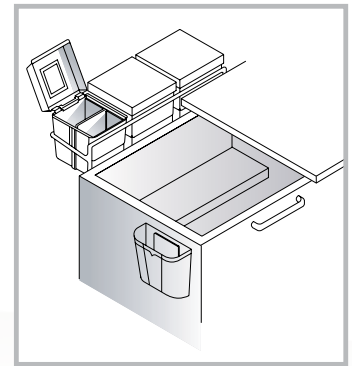

AWL1 LINER ORGANIZER*

ALABAMA AMALGAMATOR WELL LINER

18" W x 16" D

One size only for MFB217SS and MFB217FB. 1.75" side walls with 10" x 10" amalgamator section and balance, divided into 7 compartments.

\$69.00

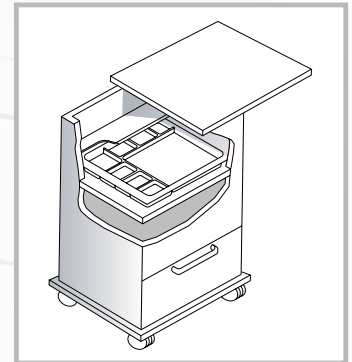

MC553SP MOBILE

UTILITY MOBILE

16.5" W x 18.5" D x 31.5" H

Designed for use with ultrasonic scaler, curing lights, electrosurge, etc. Includes one instrument drawer and two adjustable shelves. Shelves are notched in rear for electrical cord exit. Shelf width 14.5" ID.

\$260.00

MB21GR (Grey) MB21BE (Beige) HANDI-HOPPER*

With bracket and liners (pkg.20).

Available in grey or beige.

\$29.00

*Also available on Series 1000



Promotional Mobile Colors

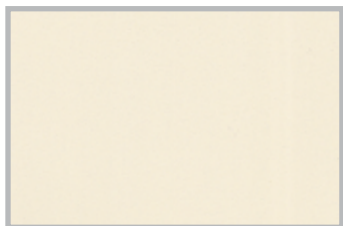

Almond • 920

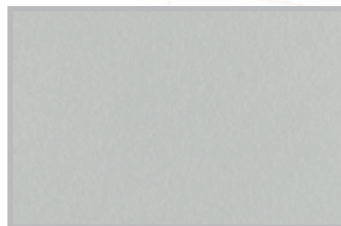

Folkstone • 927

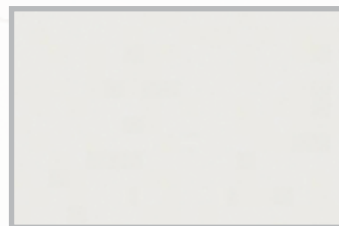

Surf • 923

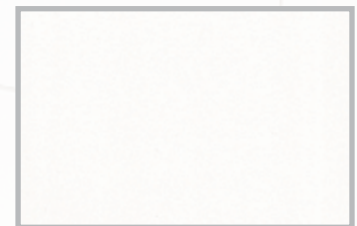

White • 949

Folkstone, Surf and White laminate colors are available on Mobile Series 1000 and Ortho Collections. Prices and colors are subject to change without notice.

Small, mighty and colorful. Made finer with Standard laminates.

Mobile Series 1000 Features and Benefits:

- Brushed nickel handles.
- Optional Solid Surface counter tops.
- 3 width options and 2 height options.
- Drawer configurations can be modified.
- Choose from many Standard laminate colors.
- PVC edging.

Shown here with optional Midnight Granite Solid Surface



DOCTOR'S MOBILE

17.5"/21.5"/25.5" W x 18.75" D x 29"/32.25" H

Includes fixed pull, four instrument drawers and two storage drawers. Vacuum Pkg options.

Laminate	Solid Surface
MFA1006 (17.5 W)	MFA1006CRN (17.5 W)
MFB2006 (21.5 W)	MFB2006CRN (21.5 W)
MFC3006 (25.5 W)	MFC3006CRN (25.5 W)



MC5054

UTILITY MOBILE
20" W x 17.5" D x 29"/32.25" H

Includes one instrument drawer. Two adjustable shelves behind door. Rear notched shelves for electrical cord exit. Accommodates a variety of dental equipment.



ALABAMA MOBILE

17.5"/21.5"/25.5" W x 18.75" D x 29"/32.25" H

Sliding counter top with fixed amalgamator well. Includes one instrument drawer, two storage drawers; power bar: flip down front. Vacuum Pkg options.

Laminate	Solid Surface
MFA1017 (17.5 W)	MFA1017CRN (17.5 W)
MFB2017 (21.5 W)	MFB2017CRN (21.5 W)
MFB2017FF (21.5 W)	MFB2017FFCRN (21.5 W)
MFC3017 (25.5 W)	MFC3017CRN (25.5 W)

FF = Fixed Front



NORTH CAROLINA MOBILE

17.5"/21.5"/25.5" W x 18.75" D x 29"/32.25" H

Includes three instrument drawers. One storage drawer. Pull-out amalgamator drawer with drop leaf door. Sliding side shelf. Vacuum Pkg options.

Laminate	Solid Surface
MFA1018 (17.5 W)	MFA1018CRN (17.5 W)
MFB2018 (21.5 W)	MFB2018CRN (21.5 W)
MFC3018 (25.5 W)	MFC3018CRN (25.5 W)

Our Hard Working Mobile Series 1000 cabinets can be customized with any Standard laminate colors.



Discover MCC's Ortho Collection - Designed with Orthodontists in mind.

Ortho Features and Benefits:

- Doctor and Assistant instrumentation both within easy reach.
- Stationary model incorporates a complete utility center with hollow base design.
- Full Extension soft close drawers offer ample storage for orthodontic supplies.
- Convenient roll out shelf for charting and/or keyboard use.
- Available in both mobile and stationary models.
- Choice of standard or computer dedicated units.
- Choose from many colors with both solid surface and laminate top options.



Shown with MCT520PM Dr. Control, Syringe (holder bar) and optional MCVK1PK Assistant Vacuum Kit.



Our Ortho Collection of dental furniture is designed to maximize flexibility and mobility in your Orthodontic practice. Our unique, angled design achieves the ideal patient proximity.

Two sizes and models:

- MFO2421 - 24" x 21"
- MFO2428C - 24" x 28"

FEATURED COLORS

Choose from a wide variety of the latest solid colors and designer hues and classic wood grain patterns for your Ortho and Series 1000 orders.

LAMINATE STANDARD COLLECTION - Ortho and Mobile Series 1000



White • 949-58

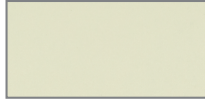

Antique White • 932-58

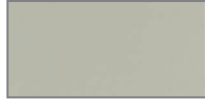

Folkstone • 927-58

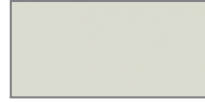

Crystal • D388-60 (Surf)

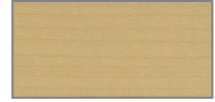

Prestige Maple • L476 Matte Finish
(Amber Curly Maple)



Pearwood • WX031



Versailles Anigre • 7923-60
(Sipping Seattle Java)



Biltmore Cherry • 7924-60



Tuxedo • L477



Starry Night • L762 Matte Finish



Milky Way • L767 Matte Finish



Portobello • L495 Urbania Finish



Truffle • L479 Matte Finish



Summer Breeze • L540 Alto Finish



White Chocolate • L492 Urbania Finish



Latitude North • L530 Alto Finish



Maritime Dune • L555 Urbania Finish



Brushed Aluminum • L474 Matte Finish

SOLID SURFACE COLLECTION - Ortho only



Light Beige • 254

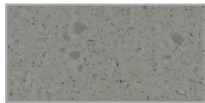

Blue Bayou • 510

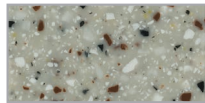

Arctic Granite • 603

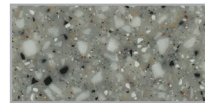

Platinum Granite • 615



Moonstone Granite • 674

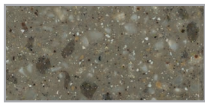

Cinder Granite • 679 AR

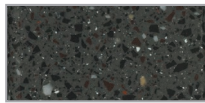

Midnight Granite • 690



Sanibel Granite • 691



Rocky Road Granite • 729 AR



Aspen Granite • 780

Other colors are available upon request, up-charge will apply.
Prices and colors are subject to change without notice.

Let us help you make your color choices.

We're here to help you choose the unit colors that best match your office style and design objectives. Ask us for assistance. We'll be happy to show you all the color choices available to you.



TAILORED SOLUTIONS
FOR YOUR DENTAL PRACTICE

Sterilization Centers • Rear Cabinets • Side Cabinets • Center Island Units • Mobiles • Orthodontic Mobiles • Pediatric Benches • Brilliance Units

1-800-388-6236

www.mccdental.com

FOLLOW US ON THE MAJOR SOCIAL NETWORKS

